



Global Water
800-876-1172 • globalw.com



Global Water

Instrumentation, Inc.

11390 Amalgam Way
Gold River, CA 95670
T: 800-876-1172
Int'l: (916) 638-3429, F: (916) 638-3270
globalw.com

WS705 Water Sampler



Table of Contents

I.	WS705 Checklist	•	•	•	•	•	•	Page	3
II.	Inspection	•	•	•	•	•	•		3
III.	Description	•	•	•	•	•	•		4
IV.	Installing the Water Sampler			•	•	•	•		5
V.	Installing the Pickup Hose	•	•	•	•	•	•		5
VI.	The Control Panel	•	•	•	•	•	•		6
VII.	Composite Sampling			•	•	•	•		8
VIII.	Discrete Sampling	•	•	•	•	•	•		8
IX.	External Trigger mode			•	•	•	•		9
X.	Specifications	•	•	•	•	•	•		11
XI.	Maintenance	•	•	•	•	•	•		12
XII.	Troubleshooting	•	•	•	•	•	•		12
XIII.	Warranty	•	•	•	•	•	•		14
XIV.	Appendix A: Sample Size vs. Head Height				•	•	•		15
XV.	Appendix B: Battery Life				•	•	•		16
XVI.	Appendix C: Input and Output Connections				•	•	•		16
XVII.	Appendix D: Replacement Parts and Accessories					•	•		17
XVIII.	CE Certification	•	•	•	•	•	•		18



Global Water
800-876-1172 • globalw.com

Congratulations on your purchase of the Global Water WS705 Water Sampler. This instrument has been quality tested and approved for accurate and reliable operation. We are confident that you will find the WS705 to be a valuable asset for your applications. Should you require assistance, our technical staff will be happy to help.

I. WS705 Checklist

1. WS705 Water Sampler with Transport Case
2. 20-Mesh Pickup Strainer w/ 15' of Hose
3. 12V Battery in Battery Enclosure
4. 3-Stage Charge Controller
5. 18 Volt Regulated Battery Charger
6. Battery Cable
7. Two Water Sensor Shorting Plugs
8. Quick-Disconnect Fitting Cap and Plug
9. WS705 Manual

II. Inspection

The WS705 unit was carefully inspected and certified by Global Water's Quality Assurance Team before shipping. If any damage has occurred during shipping, please notify Global Water Instrumentation, Inc. and file a claim with the carrier involved.

Use the checklist to ensure that everything needed to operate the WS705 Water Sampler was received.



Global Water
800-876-1172 • globalw.com

III. Description

The Global Water WS705 Sampler is designed specifically to meet a wide variety of sampling requirements including industrial discharge, process control, water and wastewater treatment plants, sewers, rivers and streams.

The sampler consists of a rugged, rainproof and lockable wheeled transport case with a comfort grip handle on top and retractable handle on the back. The enclosure houses a control panel with peristaltic sampling pump, sample bottle, pickup hose and strainer with quick-disconnect fittings, a rechargeable battery with 3-stage charge controller in a self contained battery box, and a energy efficient regulated battery charger.

The WS705 Sampler can take individual "time weighted" composite samples, or it can be set to take a full-bottle discrete or "Grab" sample. This is accomplished with a Sample Size control having one position being reserved for "Full" bottle". A Sample Interval control sets the time between individual composite samples and has a provision for allowing the sampler to be triggered from external sources.

A Start Delay timer can be set to start sampling after a preset time. This allows multiple samplers to be deployed in the field and have them turn on at the same time. The delay can also be used to hold off sampling to let the water source flush out debris or other contaminants.

After each sample, the pump will reverse for 15 seconds. This clears any debris from the strainer at the end of the pickup hose and also empties water from the hose so the next sample is not contaminated by the previous one.

Inputs are provided for triggering the sampler based on water level, a rain gauge sensor or a signal from an external process controller or other monitoring device. An output is also available for monitoring when the pump is taking samples, using a data logger or similar recording device.



Global Water
800-876-1172 • globalw.com

IV. Installing the Water Sampler

- a. The sampler should be placed upright (it will not work if placed on its back or side).
- b. Open the sampler and remove the battery charger from the unit. Store the charger for later use.
- c. Remove the pickup hose and connect it to the sampler using the quick-disconnect fitting on the side of the enclosure. Place the protective cap over the protective quick-disconnect plug and save for future use.
- d. To secure the sample bottle:
 1. Screw the bottle cap/float switch onto the sample bottle
 2. Place the bottle into the sampler enclosure
 3. Insert the end of the peristaltic pump's hose in the hole at the top of the bottle cap
 4. Plug the float switch lead into the jack on the front of the control panel
- e. The sampling unit can be secured from vandalism and strong winds by one of the following methods:
 1. Mount unit on post and lock closed
 2. Lock closed and chain handles to a solid structure (such as a tree, post, or building)
 3. Enclose and lock unit in a steel electrical box
- f. Avoid drilling holes in the enclosure if possible. If holes must be drilled in the enclosure avoid drilling through the control panel enclosure. Any holes drilled through the enclosure must be sealed with some type of sealant to prevent water from entering the case and causing equipment failure.
- g. The unit is water resistant, not water proof. The unit must be located well above the expected water level to continue to provide reliable service.

V. Installing the Pickup Hose

Remove the pickup hose from the enclosure and connect it to the sampler using the quick-disconnect fittings. Place the protective cap over the protective plug and save for future use. When storing the hose inside the enclosure, replace the protective cap and plug to keep the fittings clean of dirt and contamination. The pickup hose should be installed in a wastewater discharge channel or stream. The pickup strainer should be submerged under water and should be situated to avoid contact with the channel bottom.



Global Water
800-876-1172 • globalw.com

VI. The Control Panel

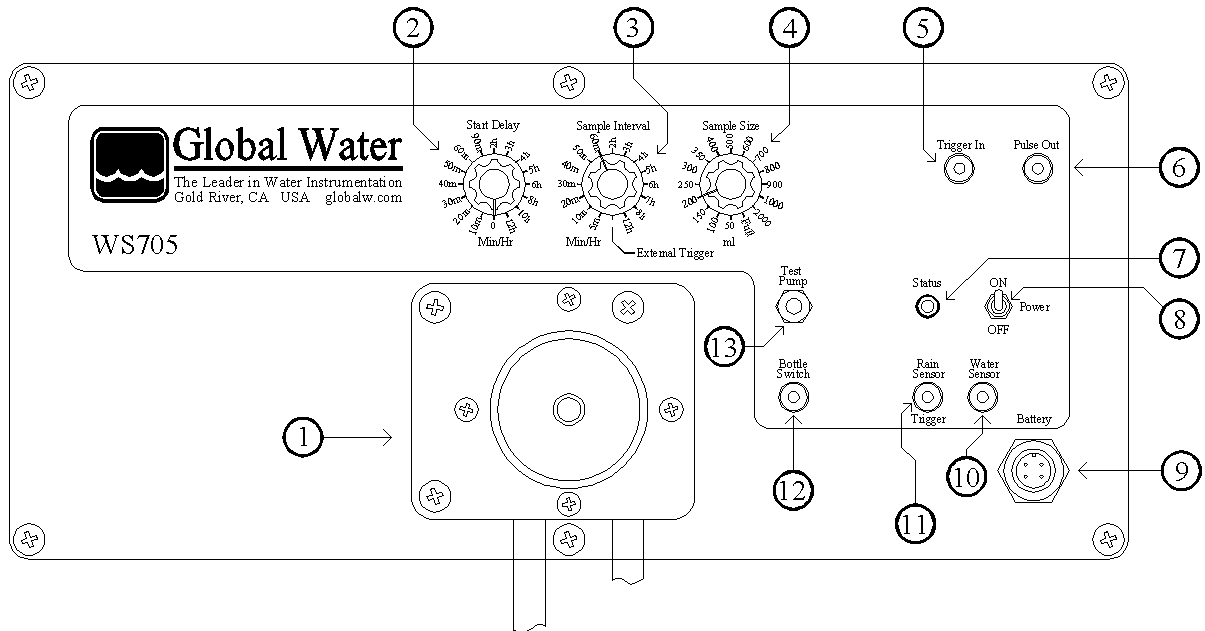

1. Pump.
2. Start Delay: This setting delays sampling by a preset amount of time. If no delay is desired, set the control to zero. Only the first sample taken by the pump is delayed, except as described later in the section titled "External Trigger Mode".
3. Sample Interval: Sets the time interval between composite samples. The "External Trigger" position is reserved for using the Trigger and Rain Sensor inputs to initiate sampling as described later in the section titled "External Trigger Mode".
4. Sample Size: Sets the size for a single composite sample. The sample size settings are approximate and apply to a head height of four feet. The switch position marked "Full" causes the pump to work as a discrete sampler, filling the bottle full in one sample. Note: In the Full position, the sampler will shut off the pump after one hour, even if the bottle is not full.
5. Trigger In: This input works in "External Trigger" mode only, as selected by the Sample Interval control. A signal from an external device will cause a single sample to be taken according to the Size control. The External Trigger mode is described in more detail later in the section titled "External Trigger Mode". Refer to the Specifications section for details about the input pulse requirements.



Global Water

800-876-1172 • globalw.com

6. Pulse Out: This output sends a pulse to an optional recording or monitoring device each time the pump starts, allowing the time of the sample event to be recorded. Refer to the Specifications section for details about the output pulse.
7. Status: This red LED indicates the status of the sampler. While the sampler is waiting to be triggered, the light remains off. Once triggered, the LED will blink once every two seconds while the Delay or Interval timers are running and while the pump is operating. The LED remains lit constantly when the sample bottle is full or if the bottle switch is not plugged in.
8. Power: This turns the power to the sampler on and off. *Turning the switch off for one second resets all functions and timers.*
9. Battery: Connect the battery here using the supplied battery cable.
10. Water Sensor: When an optional water sensor is plugged into this jack, sampling will not begin until the presence of water is detected (the Rain Sensor must also detect water). If this sensor input is not being used, plug one of the two shorting plugs supplied with the sampler into this jack. This input has no affect when triggering the sampler using the Trigger Input in External Trigger mode.
11. Rain Sensor: When an optional water sensor is plugged into this jack, sampling will not begin until the presence of water is detected, usually in a rain gauge (the Water Sensor must also detect water). If this sensor input is not being used, plug one of the two shorting plugs supplied with the sampler into this jack. This input has no affect when triggering the sampler using the Trigger Input in External Trigger mode. This input can also be used to take individual composite samples and is described in detail later in the section titled "External Trigger Mode".
12. Bottle Switch: The sample bottle float switch plugs into the control panel here. For sampling to occur a float switch must be plugged in and the bottle must not be full. If the Status LED remains lit all the time, check this connection.
13. Test Pump: Pressing this button tests the operation of the pump. This button will run the pump regardless of whether the bottle switch is plugged in or not. The pump runs forward for as long as the button is held down, then reverses for an equal amount of time or 15 seconds, whichever is less.



Global Water
800-876-1172 • globalw.com

VII. Composite Sampling

A composite sample is a series of smaller samples put into the same bottle, thus showing an “average” sample over time. Set the Interval control to the desired time between samples (do not select the External Trigger position). Set the Size control to the desired sample size. Note that the sample size settings are approximate and apply to a head height of four feet. For heights other than four feet, refer to the chart inside the front of the sampler.

The sampler starts timing when both of the optional Rain and Water Sensors detect moisture. If you do not have the optional water sensors or do not need them for your application, defeat them by plugging one of the two shorting plugs supplied with the sampler into their jack. If both inputs are defeated, the sampler starts up triggered when the power switch is turned on. The Status LED starts blinking every 2 seconds once the sampler is triggered.

The Start Delay timer begins running when the sampler is triggered by the Rain and Water Sensors and the first sample is taken when the timer expires. If the Delay control is set to zero, sampling begins immediately. The delay timer only applies to the first sample taken, except as described later in the section titled “External Trigger Mode”. At the end of each sample, the pump reverses for 15 seconds.

Sampling continues as Trigger-Delay-Sample-Reverse-Interval-Sample-Reverse-Interval-Sample-Reverse ... until the sample bottle is full. When the bottle is full, the Status LED remains lit constantly.

VIII. Discrete Sampling

A discrete sample is a single sample put into the same bottle, thus being a sample at one point in time. Set the Sample Size control to “Full”. Once started, the pump will continue to run until the sample bottle is full.

As with composite sampling, the Start Delay timer begins when the sampler is triggered by the Rain and Water Sensors and the first sample is taken when the timer expires. If the Delay control is set to zero, sampling begins immediately. The Status LED blinks every 2 seconds while the delay timer or the pump is running and remains lit constantly once the sample bottle has been filled. At the end of sampling, the pump reverses for 15 seconds.



Global Water
800-876-1172 • globalw.com

IX. External Trigger Mode

When the Sample Interval control is set to the “External Trigger” position, the sampler can be triggered externally by either the Trigger In jack or the Rain Sensor input. This mode is useful in applications where sampling occurs based on readings from a process controller, SCADA system, flow monitor, auto-dumping rain gauge or other remote monitoring devices.

Using the Rain Sensor as a trigger source:

This mode is normally used with an auto-dumping rain gauge that empties itself every 24 hours. Set the Sample Interval control to External Trigger. Set each pumps Size control based on desired composite sample size or set to Full for a discrete sample.

The sampler will be triggered when both the Rain and Water Sensors detect moisture. If the Water Sensor is not needed, use one of the shorting plugs supplied with the sampler to defeat it by plugging it into the Water Sensor input jack. Place the Rain Sensor at the desired height in the rain gauge. When the Rain Sensor detects moisture, the sampler will start.

Once triggered by the Rain Sensor, the Start Delay timer begins running and the Status LED begins blinking every 2 seconds. When the timer expires, the pump takes a sample based on the Sample Size settings. When the sample is complete, the pump reverses for 15 seconds, then stops. The sampler cannot be re-triggered until the rain gauge empties itself and the Rain Sensor goes dry. The next time the sensor detects moisture, the Start Delay timer will start over again and another sample will be taken when it expires.

If the pump’s Sample Size control is set to take a full-bottle discrete sample, further triggers will have no affect. If the pump is set to take composite samples, each one will represent the conditions at the time of that “qualified rain event”. This process will continue until the sample bottle is full and the Status LED remains lit all the time.

Using the Trigger Input as a source:

This input is generally used for connecting to a flow monitor, processor controller, or other external monitoring device.

When using the Trigger In input jack, leave the Rain Sensor input jack disconnected.

Upon being triggered by the Trigger Input, the Start Delay timer begins running. When the delay timer has expired, the pump takes a sample based on the Sample Size setting.



Global Water
800-876-1172 • globalw.com

Holding the Trigger Input active past the end of the sample will cause the pump to continue until the Trigger Input is released. When the sample is complete, the pump reverses, then stops.

Flow Proportional Sampling

- a. To set the WS705 up to take flow proportional samples, a flow monitor must be attached to the control panel. In this configuration, the sampler is designed to take a sample every time a specific amount of flow has passed through the flow monitor.
- b. The flow monitor must provide a momentary switch closure (250ms or longer) or a pulse of 4-30VDC, whenever a sample is to be taken. The output of the flow monitor must be wired to a 2-wire RCA jack as shown in Appendix C. The phone plug is then inserted into the Trigger In jack on the control panel.
- c. Set the Sample Interval knob to External Trigger mode and the Sample Size knob to the desired sample size. The sample will be taken, flow proportionally, as directed by the flow meter.



Global Water
800-876-1172 • globalw.com

X. Specifications

Operating Temperature:	0° to +70°C
Dimensions	22"H X 18"W X 10"D
Weight:	26lb (Shipping Weight 28lbs)
Materials:	
Enclosure:	Expanded UV protected PVC
Bottle:	2.5 gallon Polyethylene
Pickup Hose:	15' nylon reinforced 1/4" ID polyethylene flexible tubing with 20-Mesh intake strainer and quick-disconnect fittings. 6-Mesh strainer available as option.
Pump Tubing:	Neoprene 1/4" ID, 7/16" OD
Sample Pump:	
Flow Rate:	1000 ml per minute at a 4 foot head
Type:	Peristaltic
Maximum Lift:	~20 feet
Battery:	Rechargeable 5 AH Gel Cell
Battery Life:	~1 hour, continuous pumping under load Standby: 3 months while retaining enough power to run the pump to capacity
Start Delay:	16 time settings from 0 to 12 hours
Composite Interval:	15 time settings from 5 min. to 12 hours plus an External Trigger mode setting
Sample Size:	15 composite sample sizes from 50ml to 2 liters plus a Full Bottle discrete setting (Approximate sizes at 4 foot head)
External Trigger Input:	250mS minimum pulse width Switch closure or 4-30VDC
Pulse Output:	5VDC one-second pulse 1000ohm output impedance
Bottle Switch Input:	Switch closure Input Floating read switch in bottle
Rain and Water Sensors:	Optional moisture sensors or switch closure inputs
Internal Fuse:	10A Slow-Blow
Charger	18VDC Universal Switching Supply, 2.1mm Connector, Center Positive.



Global Water
800-876-1172 • globalw.com

XI. Maintenance

Sampler

The Global Water WS705 Water Sampler requires minimal maintenance. The sampler enclosure is rainproof and rugged. Avoid exposure to extremely rough usage. Routinely wipe the carrying case and control panel face, rinse the pickup hose and debris strainer, and wash the sample bottle with mild soap and warm water. Additional plastic and glass sample bottles, neoprene tubing for the sampler pump, bottle caps/float switches, removable debris strainers, and pickup hose can be purchased from Global Water (see Appendix D section).

Battery

If the pump runs slowly, this is an indication that the battery requires recharging. Global Water recommends fully recharging batteries approximately once per month. In addition, the battery should be recharged before any extended use. NOTE: The battery life will be maximized if recharged before it drains below 11 volts.

To recharge the battery, plug the included charger into the charging jack on the outside on the sampler enclosure. The WS705 has a 3-Stage charge controller installed inside the battery enclosure that will prevent over-charging. To prevent damage to the battery and controller, use only the supplied charger. Additional batteries and battery chargers are available from Global Water (see Appendix D).



XII. Troubleshooting

- a. Check that the battery is firmly connected to the control panel and confirm that it is fully charged.
- b. Press the Pump Test button on the front panel. The test button should always run the pump, regardless of the state of any of the inputs.
- c. Turn the power switch off for 1-2 seconds then back on to reset the sampler.
- d. Check the Status LED on the front panel.
 - i. The LED is off: If the water sensors are being used, check the Rain and Water Sensor inputs. Sensors must be in contact with moisture and unused inputs must have one of the shorting plugs supplied with the sampler plugged into the jack. If the Trigger Input is being used,



Global Water

800-876-1172 • globalw.com

confirm that External Trigger mode is selected on the Interval control. Check the pulses coming from the triggering device and confirm they meet specifications. Test the Trigger Input by plugging one of the shorting plugs supplied with the sampler into the jack.

- ii. The LED is blinking: Check the Start Delay and Interval settings. The sampler may be waiting for the Delay timer to run out or it may be timing the interval between composite samples.
- iii. The LED is on constantly: Check the bottle switch. The light remains on when either the sample bottle is full or when the float switch is not plugged in or working properly. Plug one of the shorting plugs supplied with the sampler into the bottle switch jack, the light should go out or start blinking.

Other issues

- e. Call us for tech support: 800-876-1172 or 916-638-3429 (many problems can be solved over the phone). Fax: 916-638-3270 or Email: globalw@globalw.com.

Be prepared to describe the problem being experienced including specific details of the application and installation and any additional pertinent information.

- f. In the event that the equipment needs to be returned to the factory for any reason, please call to obtain a RMA # (Return Material Authorization). Do not return items without a RMA # on the outside of the package. Decontaminate the WS705 prior to returning.

Include a written statement describing the problems.

Send the package with shipping prepaid to Global Water's factory address. Insure the shipment, as the warranty does not cover damage incurred during transit.

- g. When calling for tech support, please have the following information ready:
 1. Model #.
 2. Unit serial number.
 3. P.O.# the equipment was purchased on.
 4. Global Water's sales number or the invoice number.
 5. Repair instructions and/or specific problems relating to the product.



Global Water
800-876-1172 • globalw.com

XIII. Warranty

- a. Global Water Instrumentation, Inc. warrants that its products are free from defects in material and workmanship under normal use and service for a period of one year from date of shipment from factory. Global Water's obligations under this warranty are limited to, at Global Water's option: (I) replacing or (II) repairing; any products determined to be defective. In no case shall Global Water's liability exceed the products original purchase price. This warranty does not apply to any equipment that has been repaired or altered, except by Global Water Instrumentation, Inc., or which has been subject to misuse, negligence or accident. It is expressly agreed that this warranty will be in lieu of all warranties of fitness and in lieu of the warranty of merchantability.

- b. The warranty begins on the date of the product's invoice.



Appendix A: Sample Size Calibration

Use the following graph to see how sample size changes with head height. The Sample Size controls on the control panel are calibrated at a height of 4 feet. Increasing the head height decreases the sample size by a predictable amount. To determine the appropriate Sample Size setting for a desired volume; find the sample size on the horizontal axis, follow straight up to the line corresponding to your head height, then look across to the vertical axis and read the setting for the Size control on the control panel.

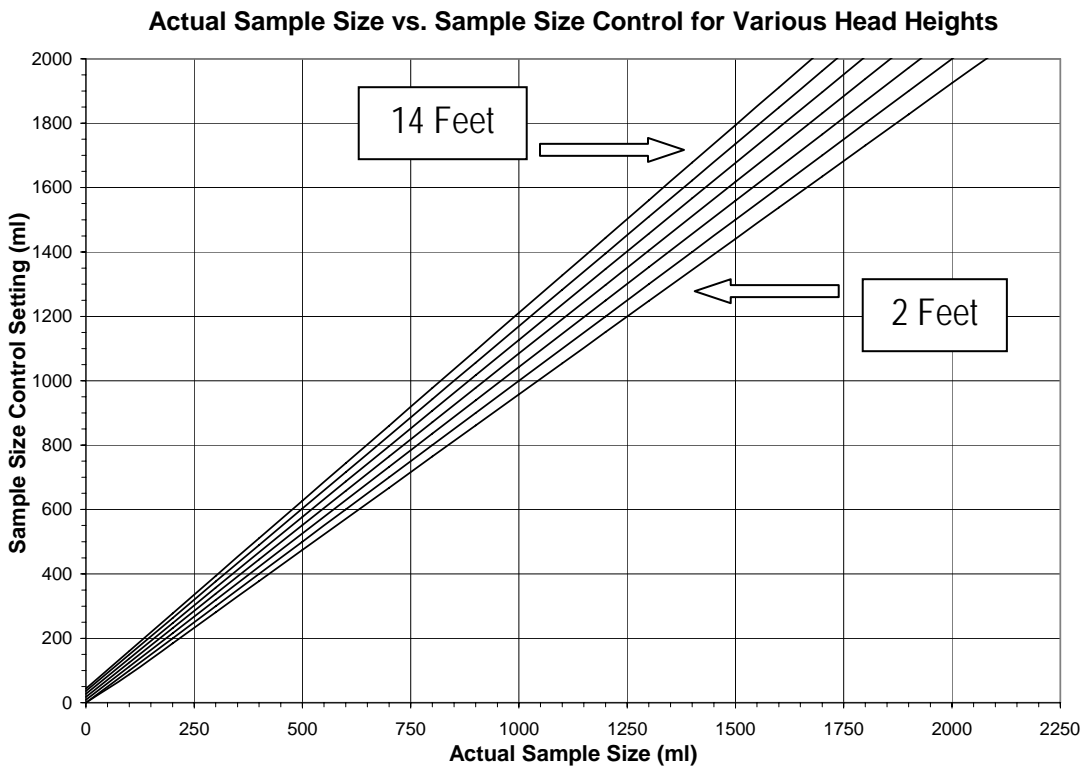



Appendix B: Battery Life

While battery life depends on several factors such as charge, condition and temperature; it can generally be assumed that the sampler can be deployed in the field for 3 months waiting to be triggered, while still retaining enough charge to run a single pump for one hour (about 10 gallons).

The battery should generally be charged at least once per month and the voltage should not be allowed to fall below 11 volts. The internal charge controller will prevent the overcharging of the battery if the charger is left connected all the time.

Appendix C: Input and Output Connections

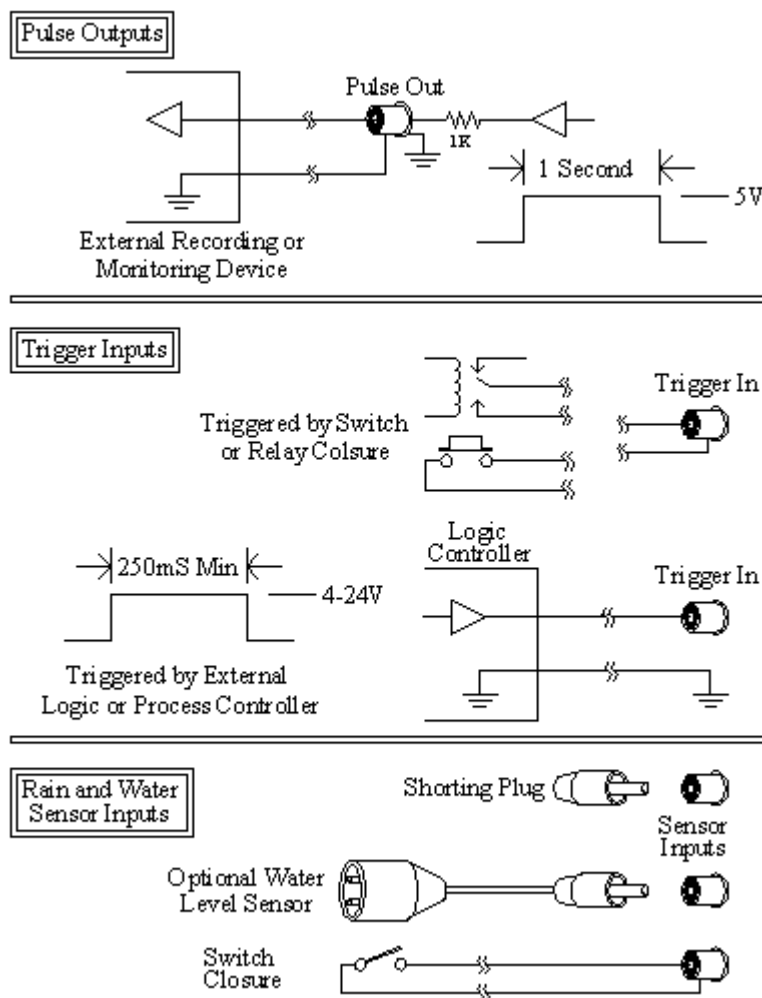



Global Water
800-876-1172 • globalw.com

Appendix D: Replacement Parts and Accessories

<u>Part Description</u>	<u>Part Number</u>	<u>Unit</u>
12V 5Ah Battery	00-010	Each
Battery Charger	01-998	Each
2.5 Gallon Plastic Sample Bottle	00-419	Each
2.5 Gallon Bottle Cap/Float Switch	CA0200	Each
1 Gallon Glass Sample Bottle	00-835	Each
1 Gallon Glass Bottle Cap/Float Switch	CA0250	Each
Replacement Pickup Hose	00-546	Feet
20-Mesh Pickup Strainer Assembly	CA0600	Each
Replacement 20-Mesh Strainer	01-881	Each
Optional 6-Mesh Strainer	01-945	Each
Quick-Disconnect Fitting Plug & Cap	CA0850	Each
Tubing Quick-Disconnect Fitting	CA0860	Each
Replacement Pump Tubing	00-744	Feet
Rain and Water Sensors	CA0400	Each
Auto-Drain Rain Gauge	CH0000	Each
Complete Stormwater Kit	CTU000	Each



Global Water
800-876-1172 • globalw.com

Declaration of CE Conformity

Global Water Instrumentation, Inc.

11390 Amalgam Way
Gold River, CA 95670 USA
FAX: 00 1 916 638 3270
Phone: 00 1 916 638 3429

declares that the Products:

Product Name: Wastewater Samplers

Model Number: WS700, WS750, WS705, WS755

conforms to the following European Council directives:

Low Voltage Directives: 2006/95/EC; Requirements covering all health and safety risks of electrical equipment operating within certain voltage ranges.

According to the following standards:
EN61010-1: 2001

Electro-Magnetic Directives: 2004/108/EC; Requirements to prevent electrical and electronic equipment from generating or being affected by electromagnetic disturbances.

According to the following standard:
EN 61326-1: 2006

Batteries Directive: 2006/66/EC; Requirements regarding the proper handling and disposal of batteries and accumulators.

Global Water hereby certifies that the product stated above conforms to all directives and standards required for it to bear the CE mark.

Dale Daniel
Engineering Manager
Global Water Instrumentation, Inc.